

IONIZER USER MANUAL

Model 3890E

CoreStat® Self-Balanced
Wide Coverage Ionizing Blower



IONIZER USER MANUAL

Model 3890E

CoreStat® Self-Balanced
Wide Coverage Ionizing Blower

Contents

1. Core Insight Introduction	4
2. Ionization Technology	5
A. Steady State DC Ionization	
B. AC Ionization	
C. Bipolar Pulsed AC Ionization	
D. High Frequency AC Ionization	
E. Pulsed DC Ionization	
3. Application Guide	7
A. Basic ESD Control	
B. Ionization for CDM/CBE Controls	
4. Cautions and Personal Safety	8
A. Cautions	
B. Personal Safety	
5. General Specification	9
6. Drawings	10
7. Setup and Operation	10
A. Introduction	
B. Contents in the box	
C. Descriptions for Model 3890E	
D. Installation	
E. Turning on the ionizer	
F. Alarm	
8. Maintenance	17
9. Warranty and Services	18

Core Insight Introduction 1

Core Insight, Inc. is an ionization system manufacturer and supplier to ESD and contamination control application. Core Insight, Inc. also provides ESD Test and Measurement equipment, Professional Static Auditing Kits, EMI Noise Filters and EOS/ESD Technical Services such as ESD Training, Process Assessment, ESD Control Program Development and Product Qualification Testing per ANSI/ESD Standards.

Core Insight, Inc. is a leading company for ESD and contamination control in the fields of semiconductors, flat panel displays, automotive, and general electronic manufacturing industries. Core Insight, Inc. was founded in 2003 and business partnership with ProStat Corporation, ON Filter, Monroe Electronics, Electro-Tech Systems, and Dangelmayer Associates etc.

2 Ionization Technology

A. Ionization Theory

Ionization solution has been used many years in electronic industry. Electrical ionization technology is most common design for many applications. Some ionizers designed for ESD application and some of them are contamination control in high technology manufacturing environment. Both are different purpose and may not work in both applications. Follows are the brief summary of differences and user guide for each applications.

B. Cleanroom Contamination Application

Electric field is one of strong force to attract particles on wafer, glass panel, printed circuit board and other insulator materials. To minimize this force, room ionization is the best solution in high technology and other cleanroom environment.

Pulsed DC ionization technology is the well known solution over many years to minimized air borne particle attraction in cleanroom environment. Using with laminar flow, generated ions can move long distance and wide coverage areas. This will significantly reduce the force between particles and sensitive devices such as wafer, flat panel display and medical items. In results, room ionization improves product yields and less losses.

C. ESD Control Application

Voltage (or Potential) difference is the reason why ESD event occurs and lead to device damage. Ionizer makes this voltage difference to the same or minimize the level between objects to avoid ESD damage or make it happen at the safe level.

Steady-State DC ionizer is provide high ion current to objects and maintain low peak (or offset) voltage on it. This makes minimize ESD risk in production and suitable for CDM ESD control in control program.

2 Ionization Technology

CoreStat® Self-Balanced Ionizers developed based on steady-state DC technology and upgraded the ground isolated power circuit design. It can maintain low peak (or offset) voltage performance by intrinsic balancing circuit design with longer maintenance cycle time. It does not require calibration or adjust to maintain low offset voltage and it needs to cleaning emitter points for decay performance.

D. AC Ionizations and Application

Core Insight, Inc. provides several AC ionization systems. Conventional AC ionizer for industrial applications such as roll to roll or winding & unwinding of paper, film and non-ESD sensitive areas. Bipolar Pulsed AC ionizer is output parameter adjustable technology to meet each application requirements. High Frequency AC has adopt piezo crystal power supply for neutralize charge on insulative materials in small package. AC ionizer generates more Ozone than DC in the environment and may cause of side effects in sensitive device handling areas.

All ionizers performed and tested per ANSI/ESD STM3.1 and other documents such as ANSI/ESD SP3.3, ANSI/ESD SP3.4 and ANSI/ESD SP3.5.

For more detail information about ionizer solution and technical support needed, please feel free to contact our sales representative at sales@coreinsight.co.kr or your local contacts.

3 Application Guide

A. Basic ESD Control

Basic ESD control is mandatory required to electronic industry. It follows simple principle to make equipotential between ESD sensitive items. Personal grounding, ESD safe worksurfaces and ESD safe packaging materials are the key control items in ESD protected area.

B. Ionization for CDM/CBE Controls

Due to automated process in high technology manufacturing environment, Charged Device Model (CDM) or CDM-like ESD damage becoming a major portion of device failures. Industry Council agreed to reduction of CDM protection target level down to 125V level and will impact basic level of ESD control program and organization. Not only CDM, but also Charge Board Event (CBE) like ESD issues are increasing due to device complexity and stored large amount of charge on printed circuit board.

Strategic guidance has been proposed by the EOS/ESD Association. Lowering device charged voltage level and increasing resistance of contact materials are the key strategic elements to prevent or minimize ESD damage.

ANSI/ESD S20.20 standard requires maximum allowable field strength is 125 V/inch for 200 V CDM device. Low peak (or offset) voltage of ionizer performance is important for ESD sensitive device control and control program per S20.20 based.

Core Insight, Inc. provides intrinsic low peak balancing Steady-State DC Ionizers for CDM ESD control with less maintenance.

For more detail information about ionizer solution and technical support needed, please feel free to contact our sales representative at sales@coreinsight.co.kr or your local contacts.

Cautions and Personal Safety 4

A. Cautions

Use of proper input voltage to avoid damaging the system.

Verify input power cable from DC adapter or FMS terminal connection between ionizer and equipment power supply before turn on the system.

Disconnection cable or power adapter from ionizer will damage the system.

Do not clean emitter point while the system is powered. This may result of additional contamination issue and possible electrical shock.

Do not open the system by un-authorized personnel while the system is powered. This will void the warranty and may result in additional cost.

B. Personal Safety

Before performing any maintenance on emitter points, it is highly recommended turn-off the system. Allow few minutes for high voltage power supplies to discharge.

5 General Specification

Input Voltage	110 ~ 240V AC, 1A Maximum
Ion Emission	Steady-State DC Technology
Ion Balance	<±10V
Discharge Time	Less than 1 sec at 30cm (high fan speed)
Air Flow	165 CFM
Alarm	Visual & Audio alarm operates ionizer balance and power failure
Monitoring	RJ-45 terminal
Operating Environment	Temperature: 15 ~ 35 °C Humidity: 35 ~ 60% RH
Material	Enclosure & Filter: ABS plastic Emitter Points: Tungsten (replaceable) Bracket: Aluminum
Dimensions(mm)	350W x 190H x 107D (without bracket) 422W x 225H x 115D (with bracket)
Weight	2.5 kg
Warranty	2-year limit warranty
Selection	1) Model 3890E: Built-in Auto-Cleaning Brush 2) Model 3890: Without Auto-Cleaning Brush

Status	Visual	Audio
Normal Operation	Green	Inactivate
HV Power Fail	RED	Continuous Sound
Balance Fail	RED Blinking	Beeping Sound

Drawing 6

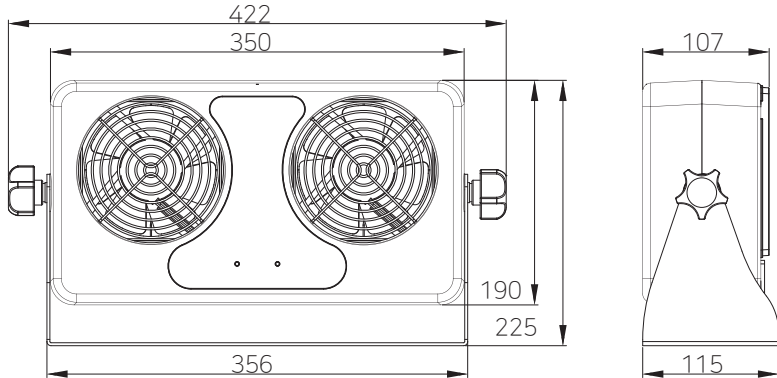

Setup and Operation 7

A. Introduction

Model 3890E ionizing blower designed wide area ionization coverage application. Model 3890E is very reliable for long-term operation without calibration and less maintenance resources for semiconductor, flat panel display and general electronic assembly applications.

Model 3890E ionizing blower can discharge less than 12 seconds at 1.5m distance. Model 3890E ionizing blower maintains intrinsic balancing less than $\pm 10V$ in ESD control area. Built-in auto-cleaning brush operates when the back-side fan filter grill is open, standby mode or power on/off sequence. Audio and visual alarm operates when ion balance exceeded the limit and power supply failure. Light weight and slim design allow versatile application and convenient use when space is limited.

7 Setup and Operation

B. Contents in the box



Model 3890E Ionizing Blower



AC Power Cable



Optional Remote Controller

7 Setup and Operation

C. Descriptions for Model 3890E Ionizers



- 1) Fan Speed Control
- 2) Fan Speed Indication LED
- 3) IR Remote Control Receiver
- 4) LED Indicator for Operation and Alarm
- 5) RJ-45 alarm output port
- 6) Power Switch
- 7) AC Power Terminal (INLET)
- 8) AC Power Terminal (OUTLET)

7 Setup and Operation

D. Installation

Place the ionizer in the desired location. (See the discharge time performance data on specification for proper reference distance selection). Ionizer is powered by 100~240V AC with 50/60Hz and plug into a properly grounded AC receptacle with the correct voltage to avoid product failure.

E. Turning on the ionizer

Use the on/off switch on the back side of the unit to turn on the ionizer. The green LED will light. Once the ionizer is powered on, its position and angle may be re-adjusted to achieve optimum discharge time within the application area.

F. Fan Speed Adjustment

To change fan speed, user needs to press down and hold two fan speed control switches for 3 seconds on the front panel of ionizer. When user fan speed control mode, audio alarm makes beeping sound once and press up or down switch to adjust fan speed in 5 levels. Once fan speed adjusted, press and hold two fan speed control swithes again then user has set fan speed.

7 Setup and Operation

G. Remote Controller



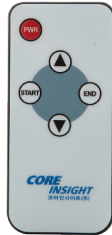

To change fan speed adjustment with remote controller, user needs press START button, then it can get into the fan speed control mode. Press Up and Down switches to adjust fan speed. Once fan speed changed, press End then user has set fan speed.



Optional IR Remote Controller(5331R)



CR2025 3V Battery

-  Power ON/OFF button
-  Remote controller starting button to set
-  Setting value saving and remote mode stop button
-  Up Button
-  Down Button

7 Setup and Operation

H. Auto-Cleaning

Model 3890E has the auto-cleaning function as below

1. Cleaning emitter points - Press the **Up** button alone for 2 seconds, then Model 3890E start cleaning the emitter points for 10 seconds. Model 3890E will operate again automatically after cleaning sequence.

2. Cleaning emitter points every 24hours

1) Press the **Down** button alone of FAN speed for 2 seconds, then The Status LEDs will blink at 3 times. Model 3890E will clean the emitter point immediately and it will operate cleaning sequence at every 24 hours. To disable this function, turn off ionizer and turn on again as default non-setup mode.

2) Using with Model 5331R remote controller

Press the start button and press the Down button alone for 2 seconds. Then The status LEDs will blink at 3 times. Model 3890E will clean the emitter point immediately and it will operate cleaning sequence at every 24 hours. To disable this function, Press the start button and press the Down button alone for 2 seconds. Then The status LEDs will blink at 4 times as default non-setup mode.

I. Alarm

In an alarm status, the RED LED in front panel of the ionizer will lights on and activate audio alarm too. When ionizer does not maintain specified balance limit, alarm LED operates with beeping sound audio alarm. When ionizer high voltage power unit operates abnormal way, alarm LED operates with continous sound audio alarm.

7 Setup and Operation

J. Facility Monitoring System (FMS)

When user wants to connect FMS terminal for monitoring, connect wiring as following instructions.

FMS output signal			
Condition	Pin 2 / 4	Pin 6 / 8	Pin 7
Normal	Open	Open	High
HV Power alarm	Open	Closed	N/A
Balance alarm	Closed	Open	N/A
Port alarm	Open	Open	Low

8 Maintenance

Warning

There are no user-serviceable parts inside the ionizer. Any unauthorized service will void the warranty and may result in additional repair charge.

General Maintenance Information

Emitter point maintenance ensures continued performance of ionizer. Dirt or erosion to emitter points can be caused by a number of environmental factors, including airborne molecular contamination issue in cleanroom.

Step 1. Recommended Cleaning Materials:

- 1) Cleanroom-compatible cloth or wipe
- 2) Cleanroom approved swabs (foam is not recommended)
- 3) Cleaning solution of 50% isopropyl alcohol (IPA) and 50% deionized water mixture

Caution

Do not clean emitter points while the unit is powered. Doing so may result in additional contamination and possible shock. After removing power from the ionizer, allow few minutes for high voltage power supplies to discharge.

Step 2. Cleaning Inside of Enclosure

Moisten a cloth with the IPA solution. Wipe off any dirt that may have accumulated inside of the unit.

Step 3. Cleaning the Emitter Points

Turn off the unit or just simply open one of the fan grills when ionizer still operation mode. When the fan grill open, it will automatically powered down and no high voltage powered. Clean the emitter points and areas around the emitter points, moisten a cleanroom-compatible swab or cleaning cloth with the IPA solution, or use cleaning solution from Core Insight. Gently rotate the swab or cleaning cloth around the emitter point. After cleaning allow the emitter points for dry out about 20 minutes. Turn on the system.



Warranty and Service 9

Core Insight, Inc. provides a limited warranty for all ionizers. New products manufactured or sold by Core Insight, Inc. are guaranteed to be free from defects in material or workmanship for a period of defined schedules from the date of initial shipment. Core Insight, Inc.'s liability under its new product warranty is limited servicing (evaluating, repairing or replacement) any unit returned from customers that has not been subjected to misuse, neglect, lack of routine maintenance, repair, alteration or accident. In no event shall Core Insight, Inc. be liable for collateral or consequential damages.

To obtain service under this warranty, please contact sales representative at sales@coreinsight.co.kr or local contacts.



